

SCALE 1:30

SCALE 1:30

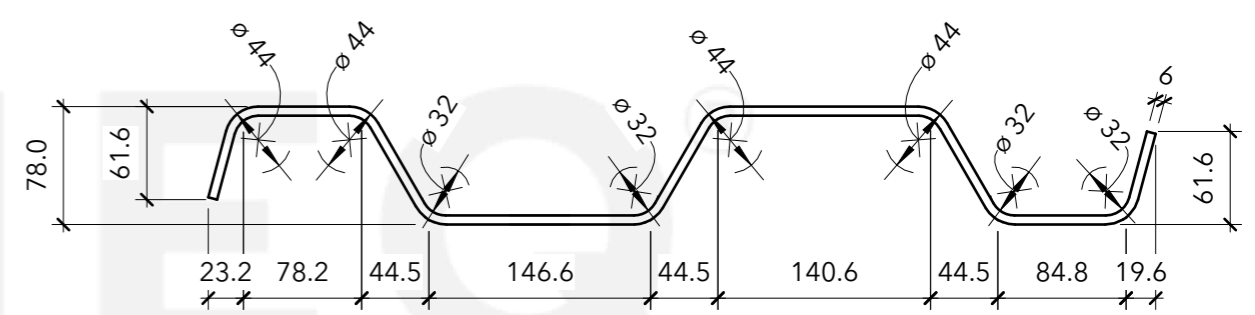

SCALE 1:5

General Comments

See Our Associated Accessories:
[KKD Driving Cap](#)
[Pitching Shackles](#)
[Trench Sheet Extractor](#)

See Our Associated Products:
[Sheet Piles - L8](#)
[Trench Sheets - KKD 600/8](#)
[Trench Sheets - Standard Lap](#)

Materials

Mild Steel - Grade S275



No.	Description	Date	Item	Component Description	Quantity

TRENCH SHEET - KKD 600/6 - 6000MM			
Weight	225KG	Serial Number	Revision
Date	25/09/2023	TR1760	
Drawn by	JT		
Checked by	Checker	Scale	As indicated @A3